

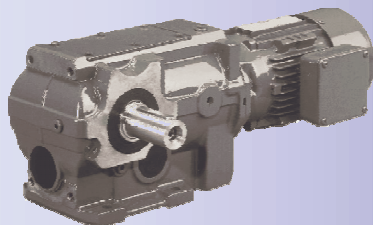

DIN EN ISO 9001:2000



SK4

HELICAL BEVEL GEAR UNITS HELICAL BEVEL GEARED MOTORS

OPERATING INSTRUCTIONS

Important Information

Intended use Gear units/geared motors are designed for the purpose of converting rotary speed and torque. They are intended for use in industrial systems and may only be used as recommended in the Rexnord-Stephan technical documentation and in accordance with the specifications on the type identification plate.

Safety instructions and warnings



DANGER



CAUTION



MAINTENANCE



INFORMATION



DANGER, RISK OF ELECTRIC SHOCK

**Operation
Warranty**

Compliance with these operating instructions is the prerequisite for ensuring trouble-free operation and acceptance of any warranty claims. Therefore, first carefully read through the operating instructions before working with the drive unit!

**Start-up
Maintenance
Installation**

The personnel entrusted with the handling, storage, installation, start-up, inspection and maintenance of the drive unit must be qualified for industrial, mechanical and electrical equipment.

Disposal

The drive unit must be disposed of in compliance with currently applicable regulations.
Housing parts, gearwheels, shafts, covers and flanges of the gear units are to be disposed of as steel scrap.
Used oil is to be disposed of in accordance with applicable environmental protection regulations.

Table of Contents

1 Principle Design, Helical Bevel Gear Units	5
1.1 Principle Design, Helical Bevel Geared Motor	5
1.2 Principle Design, U and I-Lantern	6
1.3 Geared Motors Type Code	7
2 Installation.....	9
2.1 General Conditions.....	9
2.2 Mounting Power Transmission Elements.....	9
2.2.1 Mounting the Helical Bevel Gear Unit with Solid Shaft.....	9
2.2.2 Mounting Coupling on Output Shaft.....	10
2.2.3 Mounting Coupling on Drive Shaft to Install the Motor (I-Lantern).....	10
2.2.4 Mounting a Flange Motor with Coupling.....	11
2.2.5 Mounting Helical Bevel Geared Motors with Hollow Shaft with Keyway	12
2.2.6 Mounting Helical Bevel Geared Motors with Hollow Shaft with Shrink-Fit Ring	13
2.2.7 Mounting Helical Bevel Geared Motors with Hollow Shaft with Conical Clamping Sleeve	14
2.3 Torque Support.....	16
3 Start-Up	17
3.1 Checks	17
3.2 Motor	17
3.2.1 Electrical Connection	17
3.2.2 Cable Entry.....	17
4 Maintenance.....	18
4.1 Checking Oil Level and for Leaks	18
4.2 Visual Inspection	18
4.3 Oil change	18
4.4 Regreasing	19
4.5 Backstops.....	19
4.6 General overhaul	19
4.7 Inspection and Maintenance Intervals (Overview).....	20
4.8 Prolonged Standstill.....	20
4.8.1 Long-Term Preservation	21

Malfunctions	21
6 Lubrication	22
6.1 Selection of Lubricants:	22
6.2 Oil Viscosity	23
6.3 Oil Quantity	23
6.3.1 Oil Filling Quantities for 3-Stage Bevel Gear Units	23
6.3.2 Oil Filling Quantities for 4-Stage and 5-Stage Gear Units	23
6.4 Roller Bearing Grease, Regreasing Quantities	24
6.4.1 Regreasing Quantities for U & I-Lanterns	24
6.4.2 Regreasing Quantity for Shaft Bearing	24
7 Positions of Lubricant Attachments.....	25
7.1 SK2	25
7.2 SK3 to SK9	25
7.3 SK7 to SK9 with Pre-Stage SI3	26
7.4 Regreasing Facility for Roller Bearing Grease	27
7.5 Oil Level Glass	27
7.6 Oil Filling.....	27
7.7 Draining Oil.....	27
7.8 Breathing	28
7.9 Oil Expansion Tank	28
8 EG Certificate of Conformity.....	29
9 Sales and Service Branches	31
Notes	33

1 Principle Design, Helical Bevel Gear Units

1.1 Principle Design, Helical Bevel Geared Motor

i The following illustration shows the principle design of a helical bevel geared motor. It is intended as a reference aid to the individual parts lists. Variations are possible depending on the gear unit size and version.

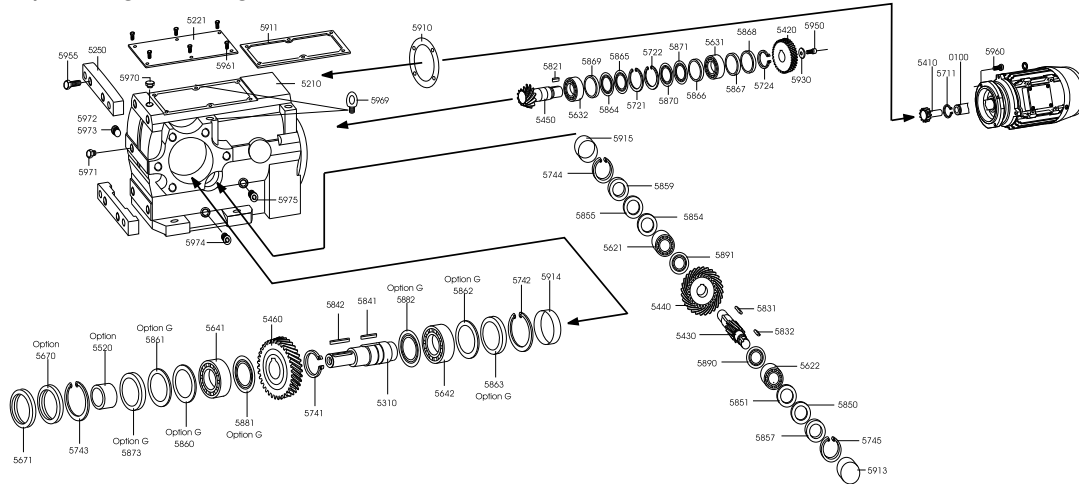

Item No.	Description
0100	Motor
5210	Housing
5221	Cover
5250	Attached foot strips
5310	Output shaft
5410	Pinion
5420	Gearwheel
5430	Pinion shaft
5440	Gearwheel
5450	Pinion shaft
5460	Gearwheel
571. / 572. / 574.	Retaining ring
5821 / 583. /584.	Feather key
585. / 586. / 587.	Support ring/shim ring
588. / 589.	Nilos ring
5910 / 5911	Gasket
5913 / 5914 / 5915	End cover
5914	End cover or protective cover for hollow shaft "H" (option)
5918	Protective cover for hollow shaft "S" (option)
593.	Washer
595. / 596. / 597.	Screw
5963	Clamping pin
597.	Screw
5621	Bearing
5622	Bearing
5631	Bearing
5632	Bearing
5641	Bearing
5642	Bearing
5670	Rotary shaft seal
5671	Rotary shaft seal

1.2 Principle Design, U and I-Lantern

The following illustration shows the principle design of a U or I-lantern. It is intended as a reference aid to the individual parts lists. Variations are possible depending on the gear unit size and version.

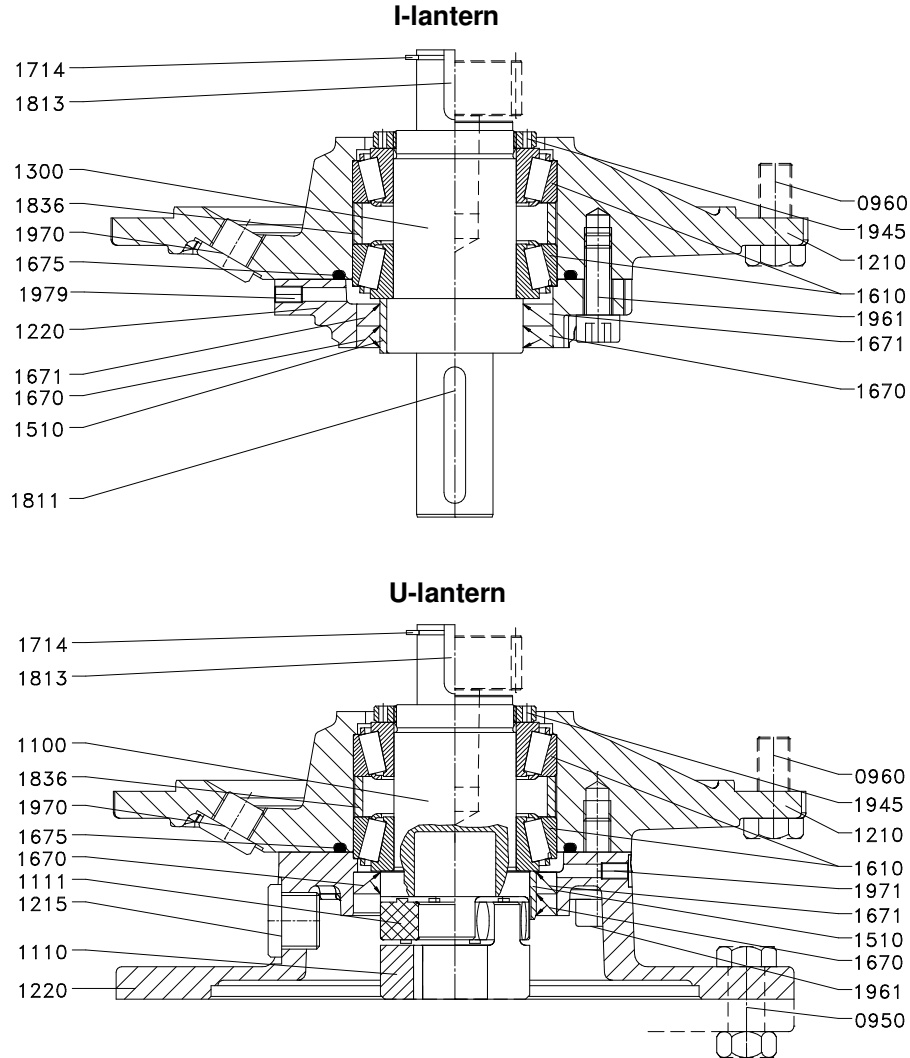

No.	Description	No.	Description
0950	Screw motor fastening	1671	Rotary shaft seal drive shaft BA NBR
0960	Screw rear frame fastening	1671	Rotary shaft seal drive shaft BA Viton
1100	Coupling kit	1675	O-ring flange NBR
1110	Coupling half, motor side	1714	Retaining ring, pinion Z1
1111	Dog, flexible element	1811	Feather key, drive shaft
1210	Lantern/frame	1813	Feather key, pinion Z1
1215	Screw plug	1836	Spacer ring, shaft unit
1220	Cover/flange/adaptor	1945	Shaft nut, shaft unit
1300	Shaft kit	1961	Screw cover/flange
1510	Bush, drive shaft	1970	Screw plug/breather screw
1610	Bearing, drive shaft	1971	Screw plug/breather screw
1670	Rotary shaft seal drive shaft BASL NBR	1979	Lubricating nipple
1670	Rotary shaft seal drive shaft BASL Viton		

1.3 Geared Motors Type Code

2-stage and 3-stage gear units														
S	K	3	4	5	6	7	8	9	10	-	11	-	12	13

Gear unit with more than 3 stages																	
S	K	3	4	5	6	7	25	26	27	8	9	10	-	11	-	12	13

3	Output flange
	Z No flange
	F B5 flange
	T B14 flange
	R Agitator version

9	Drive unit
	No designation: integrated motor
	U IEC flange motor
	I I-lantern

4	Output shaft
	H Hollow shaft with keyway
	N Solid shaft
	S Hollow shaft with shrink-fit ring
	B Hollow shaft with conical clamping sleeve

10	Accessory for gear unit
	R Backstop on drive shaft (not for sizes 2 to 6 in U-version) Specify direction of rotation

5	Size
	2 - 3 - 4 - 5 - 6 - 7 - 8 - 9

11	Motor:
-----------	---------------

6	Design index:
	6 Metric version
	7 Inch version

12	Shaft arrangement
	L Output shaft left
	R Output shaft right
	T Output shaft left and right

7	Number of stages
	C Three-stage

13	Mounting positions
-----------	---------------------------

8	Total gear ratio
----------	-------------------------

Only for gear units with more than 3 stages

25	Size, pre-stage gear unit
-----------	----------------------------------

26	Design index, pre-stage gear unit
-----------	--

27	Number of stages, pre-stage gear unit
-----------	--

Example:

S **K** ³ **Z** ⁴ **N** ⁵ **3** ⁶ **6** ⁷ **C** ⁸ **25** ⁹ ¹⁰ - ¹¹ **S112** - ¹² **L** ¹³ **1**

SK housing, no flange, solid shaft, size 3, design index 6, three-stage, gear ratio $i = 1/25$, Rexnord integral motor size 112, shaft arrangement left, mounting position 1

S **K** ³ **F** ⁴ **H** ⁵ **5** ⁶ **6** ⁷ **C** ²⁵ **1** ²⁶ **6** ²⁷ **B** ⁸ **350** ⁹ **U** ¹⁰ - ¹¹ **90** - ¹² **L** ¹³ **1**

SK housing, B5 flange, hollow shaft with keyway, size 5, design index 6, three-stage, size pre-stage gear unit 1, design index pre-stage gear unit 6, two-stage pre-stage gear unit, total gear ratio $i = 1/350$, U-lantern for motor size 90, shaft arrangement left, mounting position 1

GEARED MOTOR
CODING

2
bis

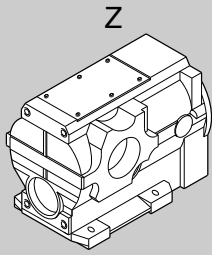

F (B5)



T (B14)



3



H



N

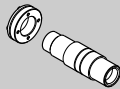

S

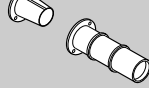

B

Shaft arrangement

MOTO-REDUCTEURS
CODIFICATION

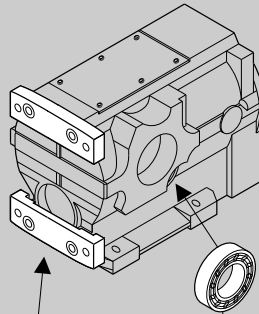
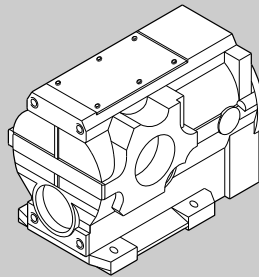

-F-

Execution with built-on mounting pads (for sizes 2 to 5)

Exécution à pattes accolées (pour tailles 2 à 5)

Ausführung mit angebauten Fußleisten (für Baugrößen 2 bis 5)

Backstop at intermediate shaft

Antidévireur à l'arbre intermédiaire

Rücklaufsperre an der Zwischenwelle

Disposition des arbres

GETRIEBEMOTOREN
TYPENSCHLÜSSEL

8

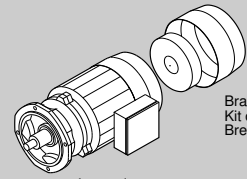

Brake kit
Kit de frein
Bremskit

Integral motor
Moteur intégré
Integrierter Motor

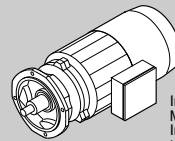

Integral brake motor
Moteur-frein intégré
Integrierter Bremsmotor

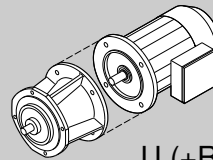

IEC - CEI

U (+R)

(+R): not for sizes 2 to 6
(+R): pas pour les tailles 2 à 6
(+R): nicht für Baugrößen 2 bis 6



I (+R)

Wellenanordnung

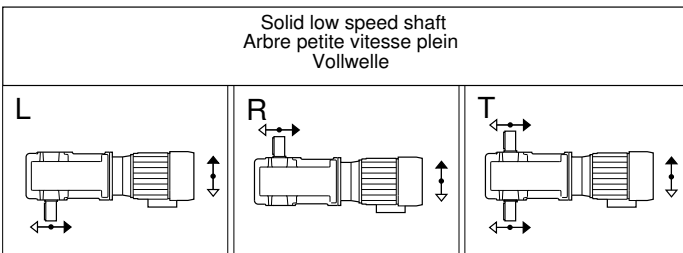

Mounting positions

Positions de montage

Einbaulagen

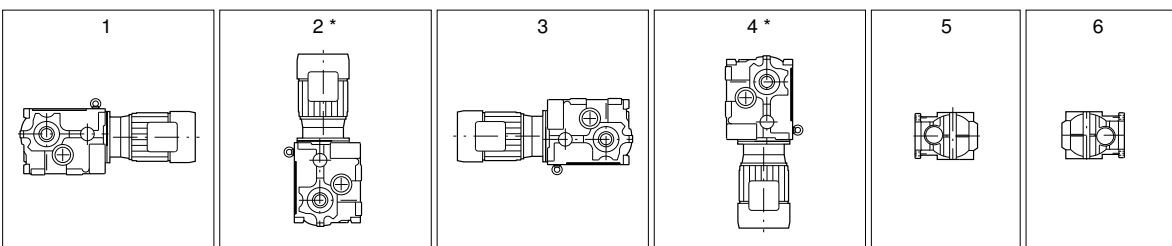

*: refer to Rexnord-Stephan

*: nous consulter Rexnord-Stephan

*: an Rexnord-Stephan wenden

2 Installation

2.1 General Conditions

- ❗ The drive units must be installed or attached free of vibration or mounted on a flat, rigid and solid frame or foundation in order to avoid vibration.

Note: The drive units must be aligned with the utmost care! Stress and strain in the housing must be avoided.

To align the gear unit, place it on the 3 mounting points and use shims to match the other point to an accuracy of less than 0.2 mm.

After the gear unit has been aligned correctly and after all the shims have been fitted, the gear unit must be firmly screwed down to the foundation. Screw class 8.8 in accordance with DIN 267. Screw size: see dimensioned drawings. The screws must be tightened to the torque requirements as specified by the manufacturer.

Trouble-free lubrication and ventilation are ensured only when the gear unit is mounted in the correct position.

It is necessary to correct the amount of lubricant and the position of the breather screw if the mounting position of the gear unit is changed.

Prior to start-up, check the position dependent oil level in the drive unit by undoing the oil level screw plug (see section 7) / at the oil inspection window on the drive unit.

Size 2 features lifetime lubrication. In this case, the surface temperature and the noise level emitted by the gear unit must be constantly monitored during the start-up procedure.

Intermediate inserts or pads made of plastic must be used if there is a risk of electrochemical corrosion between the gear unit and system. Connect the gear unit housing to earth.

The cooling air intake of the motor must not be obstructed.

2.2 Mounting Power Transmission Elements

2.2.1 Mounting the Helical Bevel Gear Unit with Solid Shaft

- ❗ Flexible couplings should be used for direct power transmission from the gear unit to the drive machine and friction or safety couplings if there is a risk of the unit jamming.

Only use rigid couplings in connection with unsupported or overhanging shafts (e.g. with agitators or fan drives). Due to the radial forces produced, power transmission elements such as flat belts or V-belts, gearwheels and sprockets, cranks, eccentric cams etc. are to be arranged as close to the gear unit housing as possible. The bearings and drive shaft are then subject to the lowest possible load. Refer to the technical sales documentation for the maximum permissible load values.

The protective coating on the end of the shaft must be removed by suitable means prior to mounting the transmission elements.

Great care must be taken while fitting power transmission elements to the ground output shaft of the gear unit; this action can be performed using the threaded hole provided for this purpose on the end face of the shaft. Preferably, the power transmission element should be heated to a temperature of approx. 100 °C. The hole is to be dimensioned in accordance with ISO H7. All parts must be thoroughly deburred, cleaned and the fit locations lightly greased.

Avoid all knocks and impacts on the end of the shaft.

The same procedure applies for transmitting the drive power to the gear unit in connection with a free drive shaft.

2.2.2 Mounting Coupling on Output Shaft

- ❗ Observe the operating instructions provided by the coupling manufacturer. Accurate alignment and regular inspection are necessary. The maximum permissible shaft extensions for the coupling used must be observed and checked. Maintain the specified distance between the coupling halves. Only adjust the radial offset after the angle offset and the distance between the shaft ends have been checked. Recheck the angle offset after correcting the radial offset.

2.2.3 Mounting Coupling on Drive Shaft to Install the Motor (I-Lantern)

- ❗ If the gear unit is supplied equipped with an I-lantern, particular care must be taken while fitting the motor to ensure the correct distance between the coupling halves and to guarantee flush alignment of the motor shaft with respect to the input shaft of the gear unit.

Particular care must be taken when aligning the motor and mounting the coupling half supplied together with the gear unit to ensure that the following conditions (see graphic) are maintained as specified by the manufacturer.

Avoid all impacts and knocks during the mounting procedure.

Aligning the coupling halves on the motor and gear unit

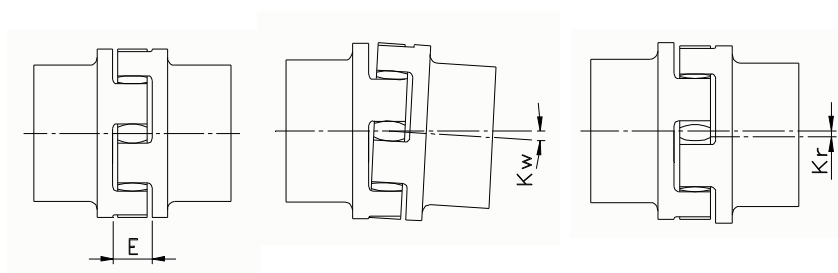

2.2.4 Mounting a Flange Motor with Coupling

- ❗ If the unit is supplied equipped with a U-lantern and without a motor, care must be taken while mounting the flange motor to ensure that the coupling half is fitted correctly. The connecting screws must be tightened to the torque specified by the screw manufacturer. Screw strength class 8.8 in accordance with DIN 267.

Particular care must be taken when mounting the coupling half supplied with the gear unit on the motor shaft to ensure that the distance "X" is maintained (see table below). The coupling seat is to be checked by opening the screw plug item No. 1215. Avoid all impacts and knocks during the mounting procedure.

Mounting the coupling half on the IEC motor shaft

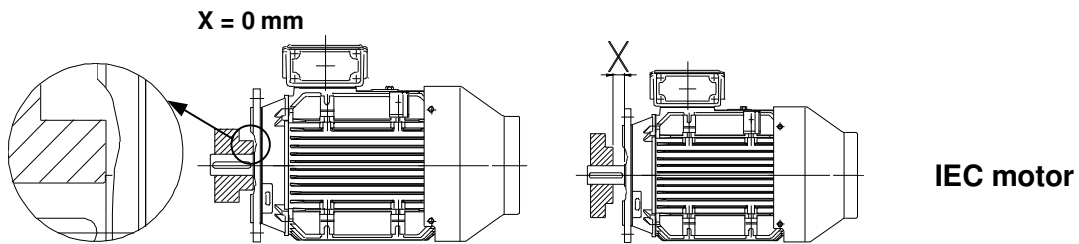

Gear unit size	Motor size										
	63	71	80	90	100 112	132	160	180	200	225	250 280
SK2.	0	0	0	0	0						
SK3. SK4.		0	0	0	0	0					
SK5. SK6.			0	0	0	0	65	65			
SK7., SK8. SK9.					0	0	65	29,5*	54	84	75
Feather key Included	Standard	Standard	Standard	8x7x15	8x7x15	10x8x40	Standard	Standard * 14x9x80	Standard	Standard	Standard
	Distance X [mm]										

2.2.5 Mounting Helical Bevel Geared Motors with Hollow Shaft with Keyway

! Assembly

- Clean and degrease contact surfaces (a) and (b).
- Grease contact surfaces (a) and (b) with "Molykote D321R" or an equivalent lubricant.
- Slide the geared motor onto the driven shaft until the surfaces (c) and (d) are positioned opposite each other. Fit a threaded rod (9), nut (10), puller ring (11), thrust washer (3) and a retaining ring (8) as required.
- Remove tools (3, 9, 10, 11).

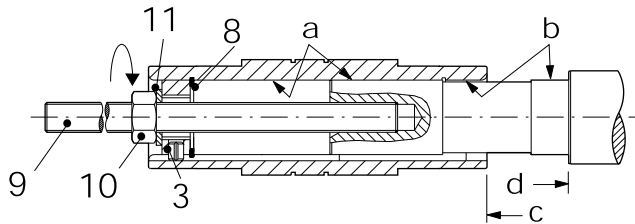

Mounting

- Fit the mounting ring (7) against the retaining ring (8). Secure the machine shaft by means of mounting screw (6) and washer (6a).
- Fit protective cover.
- If the shaft is subject to external axial loads, follow the special guidelines provided on the dimensioned drawing.

(*) An O-ring is recommended to provide increased protection against moisture.

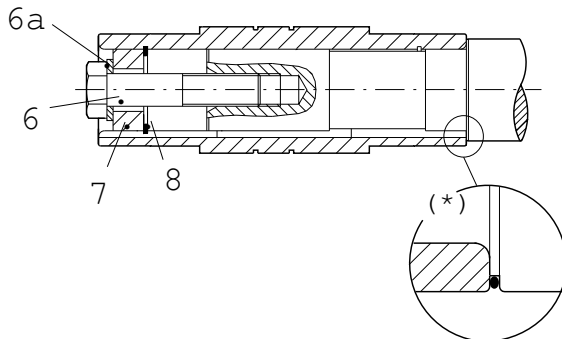

Disassembly

- Remove mounting screw (6), washer (6a), mounting ring (7) and retaining ring (8).
- Fit pulling washer (4) and thrust washer (3) and reinstall retaining ring (8).
- Fit pulling screw (5) in threaded hole in thrust washer (3).
- Remove the geared motor from the drive shaft by tightening the screw (5).

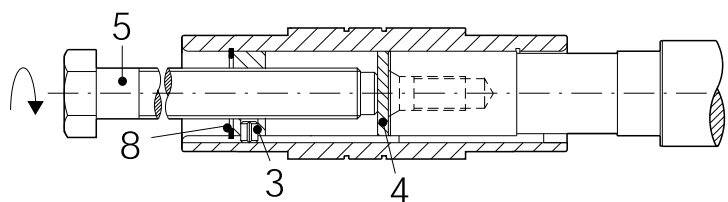

Note:

Items 3, 4, 5, 9, 10 and 11 do not belong to the standard scope of delivery, however, they are available as an option in the form of an assembly kit.

2.2.6 Mounting Helical Bevel Geared Motors with Hollow Shaft with Shrink-Fit Ring

- ❗ The shrink-fit ring supplied by Rexnord is ready for installation. Do not pull apart before initial assembly.

Assembly

- Clean and degrease contact surfaces (a) and (b).
- Grease contact surface (b) – BUT ON NO ACCOUNT contact surface (a) – with "Molykote D321R" or an equivalent lubricant.
- Slide the geared motor onto the driven shaft until the surfaces (c) and (d) are positioned opposite each other. If necessary, fit a threaded rod (9), nut (10) and a thrust washer (11).
- Remove tools (9, 10, 11).

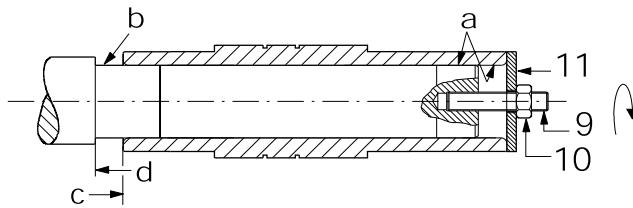

To prevent the shaft slipping, the screws must be tightened to the torque value specified in the table below in order to be able to transmit the output torque indicated on the type identification plate.

Mounting

- Install shrink-fit ring. Remove the spacer rings fitted between the outer rings (o) for transportation purposes. **IMPORTANT:** The two outer rings (o) must be arranged plane-parallel during the assembly procedure and while tightening the screws.
- Use a torque wrench to tighten the screws (8) in stages one after the other until the specified tightening torque T_A (see table) is reached. Do not tighten the screws crosswise.
- Fit protective cover.

Size	T_A (Nm)
2	12
3	12
4	12
5	30
6	30
7	59
8	100
9	250

Caution:

The screws for the shrink-fit ring must never be tightened if the shrink-fit ring is not fitted.

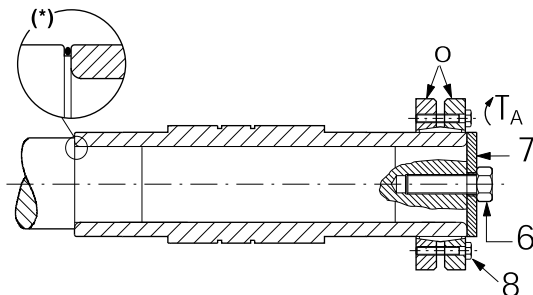

! Mounting with axial load

A mounting ring (7) and screw (6) must be fitted if the axial load is not taken up by the shoulder of the machine shaft.

Disassembly

- Evenly release all screws (8) by turning by a quarter turn one after the other.
- Remove the shrink-fit ring from the hollow shaft.
- Remove the gear unit from the drive shaft.

Note: Items 6, 7, 9, 10 and 11 do not belong to the standard scope of delivery, however, they are available as an option in the form of an assembly kit.

Cleaning and lubricating

If reused, the removed shrink-fit rings need not be disassembled into individual parts for cleaning and lubricating purposes unless they are heavily soiled. After cleaning, grease the conical surfaces with "Molykote D321R" (or an equivalent, solid lubricant with a coefficient of friction of $\mu = 0.04$).

2.2.7 Mounting Helical Bevel Geared Motors with Hollow Shaft with Conical Clamping Sleeve

! The Rexnord clamping sleeve system is supplied separately.

Assembly

- Clean and degrease contact surfaces (a) and (b).
- Grease contact surface (b) – BUT ON NO ACCOUNT contact surface (a) – with "Molykote D321R" or an equivalent lubricant.
- Fit support ring (1) either between the two shaft retaining rings (2) or between the shaft retaining ring (2) and the shoulder of the hollow shaft.
- Align the hollow shaft of the geared motor and the machine shaft. The feather key and keyway must be aligned opposite each other.
- Slide the geared motor onto the driven shaft until the surfaces (c) and (d) are positioned opposite each other. If necessary, fit a threaded rod (9), nut (10), washer (11) and a thrust washer (8). Secure the thrust washer with screws (4).
- Remove tools (8, 9, 10, 11).

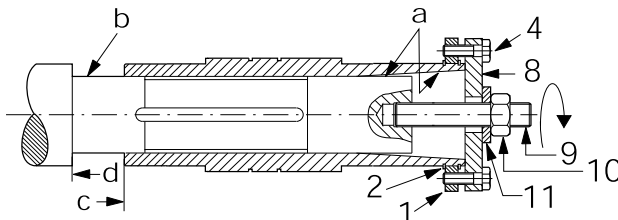

- ❗ To prevent the shaft slipping, the screws must be tightened to the torque value specified in the table below in order to be able to transmit the output torque indicated on the type identification plate.

Mounting

- Fit conical clamping sleeve in hollow shaft without using force
- Align through-holes in clamping sleeve with threaded holes in support ring (1), fit screws (4) and secure hand-tight
- Use a torque wrench to tighten screws (4) in stages one after the other until the necessary tightening torque T_A (see table) is reached
- Retighten screws after 24 hours of operation
- Fit protective cover.

Size	T_A (Nm)
4	15
5	30
6	30
7	30
8	60
9	60

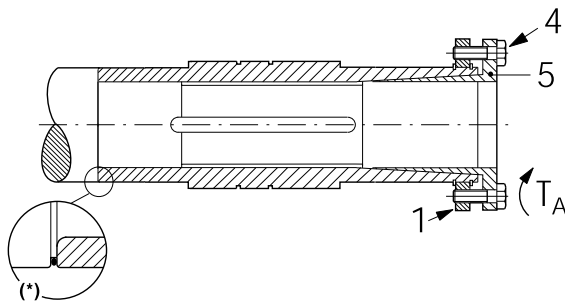

Disassembly

- Evenly release all screws (4) by turning by a quarter turn one after the other.
- Remove conical clamping sleeve (5). If the clamping sleeve (5) does not release of its own accord, fit two screws in the threaded holes and screw against the support ring (1).
- Mount thrust washer (8) with pin (4).
- Fit pulling screw (12) in threaded hole in thrust washer (8).
- Tighten pulling screw (12) in order to remove the geared motor from the machine shaft.

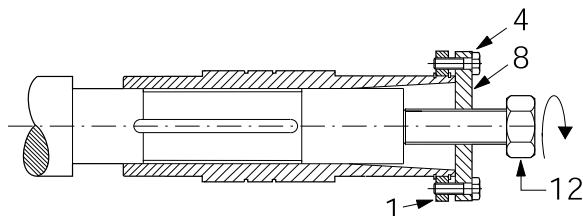

2.3 Torque Support

- ⚠ The reaction forces in connection with bevel geared motors that are used as slip-on gear units must be taken up by a torque support (optionally available) or by a flexible element (no rigid connection).

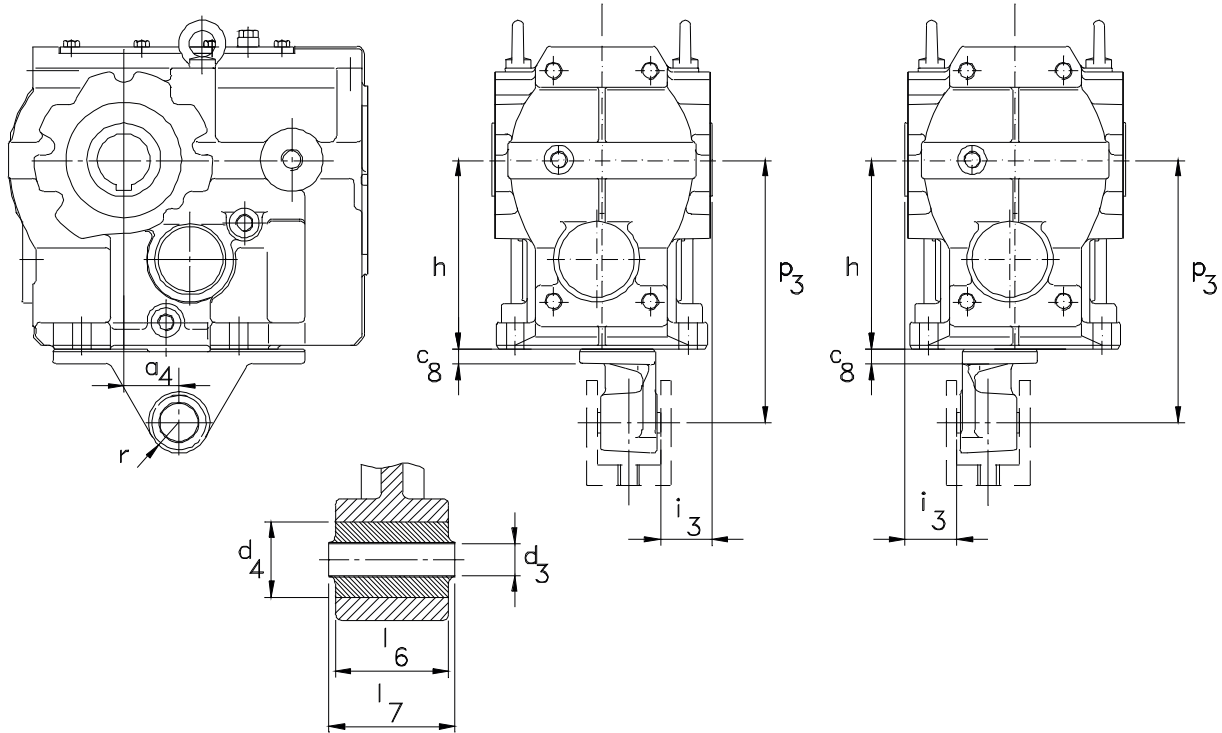

Size	a_4	r	c_8	h	i_3	p_3	d_3	d_4	l_6	l_7
SK2.	30	22.5	12	112	20	160	10.4	26	31	36
SK3.	45	29	13	140	25	200	16.4	36	54	60
SK4.	52.5	29	14	180	25	250	16.4	36	54	60
SK5.	60	41	16	212	30	300	25	52	72	80
SK6.	70	41	17	265	40	350	25	52	92	100
SK7.	74	41	20	315	45	450	25	52	92	100
SK8.	60	70	45	375	7	550	40	103	110	126
SK9.	50	70	45	450	2	700	40	103	110	126

Figures in mm

3 Start-Up

3.1 Checks

- ❗
 - The specified position-dependent oil level must be checked prior to start-up.
 - The oil inspection and drain plugs as well as the breather screws and valves must be freely accessible.
 - Check direction of rotation, especially in connection with backstops.
 - Check all mountings.
 - The check must be performed with the drive unit in the original mounting position.
 - Screw plugs must be replaced by the breather valves supplied in the position-dependent positions in accordance with section 7 “Positions of lubricant attachments”.

3.2 Motor

Note: Observe the motor operating instructions!

3.2.1 Electrical Connection

- ⚠ The cable type and cross sections must comply with regulations. The rated power and the connection method are specified on the motor rating plate. A circuit diagram is provided in the motor terminal box. Installation must be performed in compliance with EN 60079-14.

3.2.2 Cable Entry

- ⚠ All cable entry fittings must be firmly secured. Power supply cables must be connected to the terminal box and secured with a nut and spring lock washer. The wiring must be connected by a qualified electrician. Earthing of the electrical system must comply with applicable safety regulations.
- With regard to motor protection, reference is made to the applicable regulations in accordance with DIN EN 60034 or IEC 34, VDE 0105 or IEC 364.
- Particular care must be taken when closing the terminal box to ensure that the seal is fitted correctly.
- Screwed cable glands that are not required must be securely closed off.

4 Maintenance

CAUTION

- ⚠ The power supply to the motor must be disconnected before starting routine maintenance, cleaning or servicing work.

4.1 Checking Oil Level and for Leaks

- ⚠ The oil level and all seals should be checked at regular intervals every 3000 hours of operation or at least every 6 months. If the oil level is incorrect, either top up with the same type of oil or drain off and change the oil. Replace seals if leaking.

Note: If there are visible leaks, the drive unit should be shut down, even if the specified maintenance intervals are not reached, and the corresponding seals replaced.

4.2 Visual Inspection

- ☑ All surfaces are to be regularly checked for damage to the paintwork and corrosion every 3000 hours of operation and at least every 6 months. Any damage must be repaired and the protective paintwork replaced.

4.3 Oil change

- ⚠ The first oil change is recommended at 800 hours of operation. Further oil changes are to be performed at the latest after 4 years, depending on the oil type and conditions in use (see graphic below). Use clean, fresh oil from clean containers. Avoid abraded material and water entering the lubrication system. The water content must remain below 0.05 %.

When changing the oil, wash out the housing with suitable cleaning agents and remove remains of old oil.

Exception: Size 2 features lifetime lubrication, no oil change necessary.

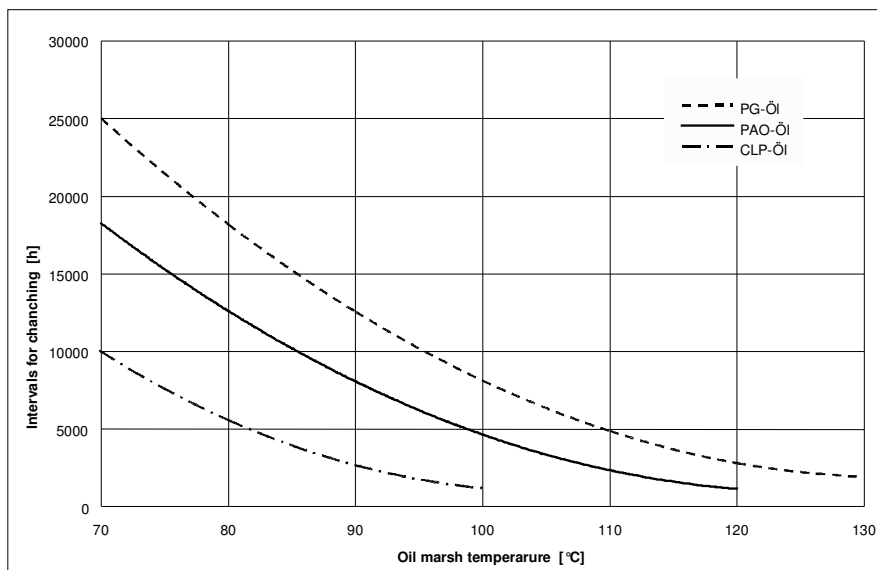

4.4 Regreasing

- ⓘ On request, the drive unit can be equipped with regreasing facilities at the roller bearings that do not run in the oil bath. Regreasing is only necessary in the mounting positions 2, 5 and 6. The roller bearings are packed in the factory with lithium grease. To achieve a longer service life, regreasing is necessary after 8000 hours of operation or after 1 year at the latest.

4.5 Backstops

⚠ The standard backstops are integrated in the drive lantern. Backstops are wearing parts and must be replaced every 6000 hours of operation, or after 3 years at the latest. The system operator must take all the necessary safety precautions to avoid failure of the backstop that may result in personal injury and/or damage to the drive unit and/or the application. It is necessary to replace the backstop under the following conditions:

- In the event of unusual wear of the gear unit or if the oil in the gear unit is contaminated, as it could have had an adverse effect on the clamping elements and bearing races in the integrated backstop.
- In the event of unusual load (stress or strain) that may have had an adverse effect on the condition of the clamping elements and bearing races in the integrated backstop. Only authorised, qualified personnel are permitted to replace the backstop or change the direction of rotation of the backstop while complying with the operating instructions for the backstop.
- Never loosen or release any part of the backstop facility while the drive unit is under load: this could impair the reversal action of the drive unit and load; the drive unit must be in a no-load condition and
- The drive must be secured to prevent unintentional or inadvertent movements.

4.6 General overhaul

- Ⓜ The drive unit should be subject to a general overhaul after 25000 hours of operation or every 5 years at the latest. All wearing parts must be checked and replaced as required. The general overhaul of the drive unit must be performed by an authorised Rexnord service workshop.

4.7 Inspection and Maintenance Intervals (Overview)

Time interval Operating hours or years		What is to be done?	Measures!
3000 hours	Every six months	Check all surfaces for damage to the paintwork and corrosion.	<ul style="list-style-type: none"> Any damage must be repaired and the protective paintwork replaced.
3000 hours	Every six months	For gear units with torque support: check damping elements.	<ul style="list-style-type: none"> Change rubber buffer if worn or brittle.
3000 hours	Every six months	Check the oil level and all seals.	<ul style="list-style-type: none"> If necessary, top up with the same type of oil/drain or change oil. If leaking, change seals and roller bearing grease.
6000 hours	Every 3 years	Oil change Change backstop	<ul style="list-style-type: none"> Only use oil approved by Rexnord-Stephan. Used oil must be disposed of in an environmentally acceptable manner. Replace backstop.
8000 hours	Every year	Regrease	<ul style="list-style-type: none"> Regrease all roller bearings as required
25000 hours	Every 5 years	General overhaul	<ul style="list-style-type: none"> Send in the drive unit to an authorised Rexnord service workshop.

4.8 Prolonged Standstill

M The protective oil film slowly dissipates from the untreated surfaces during prolonged standstill periods of the gear unit. Consequently, rust may form on the internal parts of the gear unit. The risk of rust forming depends to a great extent on the ambient conditions (moisture, maritime, tropical or chemically aggressive environment). It is therefore necessary to turn the gear unit for a few minutes every two weeks (depending on the ambient conditions) in order to avoid corrosion forming and to renew the protective oil film.



A special ventilation filter (marked with sticker) should be fitted in order to avoid the penetration of moisture into the gear unit.

If, despite the increased risk of corrosion, it is not possible to regularly turn the gear unit, the following protection measures are necessary during a prolonged standstill period:

- An oil-soluble concentrate with anticorrosion additives that are effective both in liquid as well as gaseous form should be added at a concentration of approx. 2 % to the oil. Refer to the manufacturer's specifications provided by the oil supplier for the effective duration, compatibility and exact concentration of the additive.
- All openings in the gear unit (oil drain plug, breather screw etc.) must be hermetically sealed.

4.8.1 Long-Term Preservation

M Provided the unit is stored indoors, a 2-year protection period can be guaranteed if:

- The oil in the gear unit has been drained off and the unit has been completely filled with anticorrosive oil.
- All openings in the gear unit (oil drain plug, breather valve etc.) are hermetically sealed.
- A clearly visible warning indicating **"No operational lubricant"** is displayed on the gear unit.

Note: The gear unit must not be placed into operation with the storage oil. The drained oil must be stored or disposed of corresponding to environmental protection regulations.

5 Malfunctions

If the drive unit should unexpectedly malfunction and you cannot correct the fault yourself, please contact your nearest Rexnord service centre quoting the following information.



- Data on type identification plate
- Type and extent of malfunction
- Purpose for which the drive unit is used
- Time and conditions under which the malfunction occurred

6 Lubrication

6.1 Selection of Lubricants:

⚠ The table below lists the lubricants approved by Rexnord-Stephan for helical bevel gear units.

mm2/S 0°C	ISO VG150 (1)	ISO VG220	ISO VG320	ISO VG460	ISO VG680	roller bearing grease	anticorrosion oil (2)
AMOCO			Permagear EP 320	Permagear EP 460			
ARAL	Degol BG 150	Degol BG 220	Degol BG 320	Degol BG 460	Degol BG 680	Aralub HLP 2	Konit 20 W-20
ARAL		Degol BMB 220	Degol BMB 320	Degol BMB 460		Aralub HLP 2	Konit 20 W-20
BECHEM		Berugear GS 220 BM	Berugear GS 320 BM	Berugear GS 460 BM		Bechem-Rhus L474-3	Bechem Einfettöl KSP
BP	Energol GR-XP 150	Energol GR-XP 220	Energol GR-XP 320	Energol GR-XP 460	Energol GR-XP 680	Enegrease LS-EP 2	BP Motorenschutzöl MEK 20W-20
CASTROL	Alpha SP 150	Alpha SP 22	Alpha SP 320	Alpha SP 460		Spherol EPL 2	Alpha SP 220 S
CASTROL	Alphamax Premium Gear Oil 150	Alphamax Premium Gear Oil 220	Alphamax Premium Gear Oil 320	Alphamax Premium Gear Oil 460		Spherol EPL 2	Alpha SP 220 S
CASTROL Syntheseöl			Alphasyn T320			Spherol AP3	
CHEVRON			Gear compounds EP 320	Gear compounds EP 460		Dura-lith grease EP 3	Turbine oil GST 68
ESSO-EXXON	Spartan EP 150	Spartan EP 220	Spartan EP 320	Spartan EP 460	Spartan EP 680	Beacon EP 2	Rust-Ban 623 & 343
FUCHS-DEA		Falcon CLP 220				Renolit FEP2	
FUCHS-DEA	Renolin CLP 150 Plus	Renolin CLP 220 Plus	Renolin CLP Plus 320 Plus	Renolin CLP 460 Plus	Renolin CLP 680 Plus	Renolit FEP2	
FUCHS-DEA Syntheseöl				Renolin CLP 460 Unisyn			
KLÜBER			Klüberoil GEM 1-320	Klüberoil GEM 1-460		Centoplex 2EP	Contrakor A40
KLÜBER Syntheseöl			KLÜBERSYNTH GEM4-320	KLÜBERSYNTH GEM4-460		Marson	
Lubrication Engineers	Almasol 604	Almasol 607	Almasol 605	Almasol 608		Almagard 3752	300 Monolec
MOBIL			Mobilgear 632	Mobilgear 634		Mobilux EP 3	Mobilama 524
MOBIL	Mobilgear XMP 150	Mobilgear XMP 220	Mobilgear XMP 320	Mobilgear XMP 460		Mobilux EP 3	Mobilama 524
MOBIL Syntheseöl			Mobilgear SHC 320	Mobilgear SHC 460			
OPTIMOL			Optigear 320	Optigear 460		Olista Longtime 3EP	Korrosionsschutzöl 5028 LN 697
OPTIMOL	Optigear BM 150	Optigear BM 220	Optigear BM 320	Optigear BM 460		Olista Longtime 3EP	Korrosionsschutzöl 5028 LN 697
SHELL			Omala 320	Omala 460	Omala 680	Alvania EP 2	Ensis engine oil 30
SHELL	Omala F 150	Omala F 220	Omala F 320	Omala F 460		Alvania EP 2	Ensis engine oil 30
SHELL Syntheseöl	Omala HD 150	Omala HD 220	Omala HD 320	Omala HD 460			
SRS	Winthershall Ersolan G 150	Winthershall Ersolan G 220	Winthershall Ersolan G 320	Winthershall Ersolan G 460	Winthershall Ersolan G 680	Wiolub LFP 2	Antikonrol 30
STATOIL	LoadWay EP 150	LoadWay EP 220	LoadWay EP 320	LoadWay EP 460		Statoil UniWay LI 62	
TEXACO	Auriga EP 150	Auriga EP 220	Auriga EP 320	Auriga EP 460		Multifak EP 2	Auriga EP 100
TEXACO	Meropa WM 150	Meropa WM 220	Meropa WM 320	Meropa WM 460	Meropa WM 680	Multifak EP 2	Auriga EP 100
TEXACO Syntheseöl				DEA Intor HCLP460			
TOTAL		Carter VP/CS 220	Carter VP/CS 320	Carter VP/CS 460		Total Multis EP 3	Total Rubia R 30
TRIBOL			Tribol 1100/320	Tribol 1100/460		Tribol 3020/1000-2	

Lubricant suppliers are responsible for the selection and composition of their products.

(1) For low temperatures only

(2) This storage oil is to be drained off in connection with gear units filled with anticorrosion oil. The gear units should be preferably flushed with the recommended gear oil. Consult the oil supplier if necessary.

6.2 Oil Viscosity

⚠ The oil viscosity depends on the ambient temperature at the place of installation of the gear unit. The following table shows the oil viscosity to be used.

Application	Ambient temperature [°C]		Lubricant DIN	Viscosity ISO	
SK2. ...	30	40	Öl	* CLP (CC)	VG 680
	0	40			VG 460
SK9.	0	30			VG 320
	-20	10			VG 220
Special lubricant	-25	40	Grease	** PAO / SHC	VG 460
	-25	40			VG 320
Roller bearing	-25	60	DIN 51818	2-3	

* CLP: DIN 51517 T3 mineral oil

** SHC / PAO: polyalphaolefine-based synthetic lubricant

6.3 Oil Quantity

6.3.1 Oil Filling Quantities for 3-Stage Bevel Gear Units

Type	Mounting position					
	1	2	3	4	5	6
	Litres	Litres	Litres	Litres	Litres	Litres
SK2.	0.6	2.1	1.9	2	1.7	1.2
SK3.	1.1	3.7	3.7	4	3.6	2.5
SK4.	2.4	6.7	5.5	5	5.7	4
SK5.	4	11.4	9	9	9	8
SK6.	5.5	21	15	12	12	12
SK7.	7.5	29	25	20	20	20
SK8.	13.5	46	39	32	32	32
SK9.	23	78	67	55	55	55

6.3.2 Oil Filling Quantities for 4-Stage and 5-Stage Gear Units

Type	Mounting position					
	1	2	3	4	5	6
	Litres	Litres	Litres	Litres	Litres	Litres
SK2.C1.B	0.6 + 0.45	2.1 + 1.2	1.9 + 0.85	2 + 1.4	1.7 + 0.8	1.2 + 0.85
SK3.C1.B	1.1 + 0.45	3.7 + 1.2	3.7 + 0.85	4 + 1.4	3.6 + 0.8	2.5 + 0.85
SK4.C1.B	2.4 + 0.45	6.7 + 1.2	5.5 + 0.85	5 + 1.4	5.7 + 0.8	4 + 0.85
SK5.C1.B	4 + 0.45	11.4 + 1.2	9 + 0.85	9 + 1.4	9 + 0.8	8 + 0.85
SK6.C3.B	5.5 + 0.45	21 + 1.2	15 + 0.85	12 + 1.4	12 + 0.8	12 + 0.85
SK7.C3.B	7.5 + 1.4	29 + 4.5	25 + 4	20 + 4.9	20 + 2.7	20 + 2.7
SK8.C3.B	13.5 + 1.4	46 + 4.5	39 + 4	32 + 4.9	32 + 2.7	32 + 2.7
SK9.C3.B	23 + 1.4	78 + 4.5	67 + 4	55 + 4.9	55 + 2.7	55 + 2.7

6.4 Roller Bearing Grease, Regreasing Quantities

- ① Regreasing is necessary only with the gear unit in a vertical mounting position with the motor at the top. The roller bearings are packed in the factory with Aral H grease. Only roller bearing greases approved by Rexnord-Stephan are to be used for regreasing. On the use of a backstop, the lantern is packed in the factory with a lifetime lubrication comprising Petamo GY 193 grease.

6.4.1 Regreasing Quantities for U & I-Lanterns

- Ⓜ The table below gives the regreasing necessary for the adapter (U or I-lantern).

Gear unit size	Motor size								
	63	71	80/90	100/112	132	160	180	200/225	250/280
SK2.	12	12	12	12					
SK3., SK4.		12	12	12	15				
SK5., SK6.			12	12	15	15	15		
SK7., SK8., SK9.				15	15	15	30	30	30
Regreasing quantities [g]									

6.4.2 Regreasing Quantity for Shaft Bearing

- Ⓜ If the gear unit is equipped with a regreasing facility, this facility must be filled with the quantities of grease given in the following table as per the regreasing intervals "Section 4 Maintenance".

Type	Intermediate shaft Three-stage	Output shaft
SK2.	3	6
SK3.	4	8
SK4.	5	11
SK5.	8	14
SK6.	15	18
SK7.	22	25
SK8.	30	35
SK9.	38	46
Gear unit regreasing quantities [g]		

7 Positions of Lubricant Attachments

① The positions of lubricant attachments depend on the mounting position of the gear unit and are shown in the following illustrations in mounting positions 1 to 6. The numbers in the illustrations refer to the mounting position.

7.1 SK2

① This gear unit features lifetime lubrication and has no oil screw plugs.

7.2 SK3 to SK9

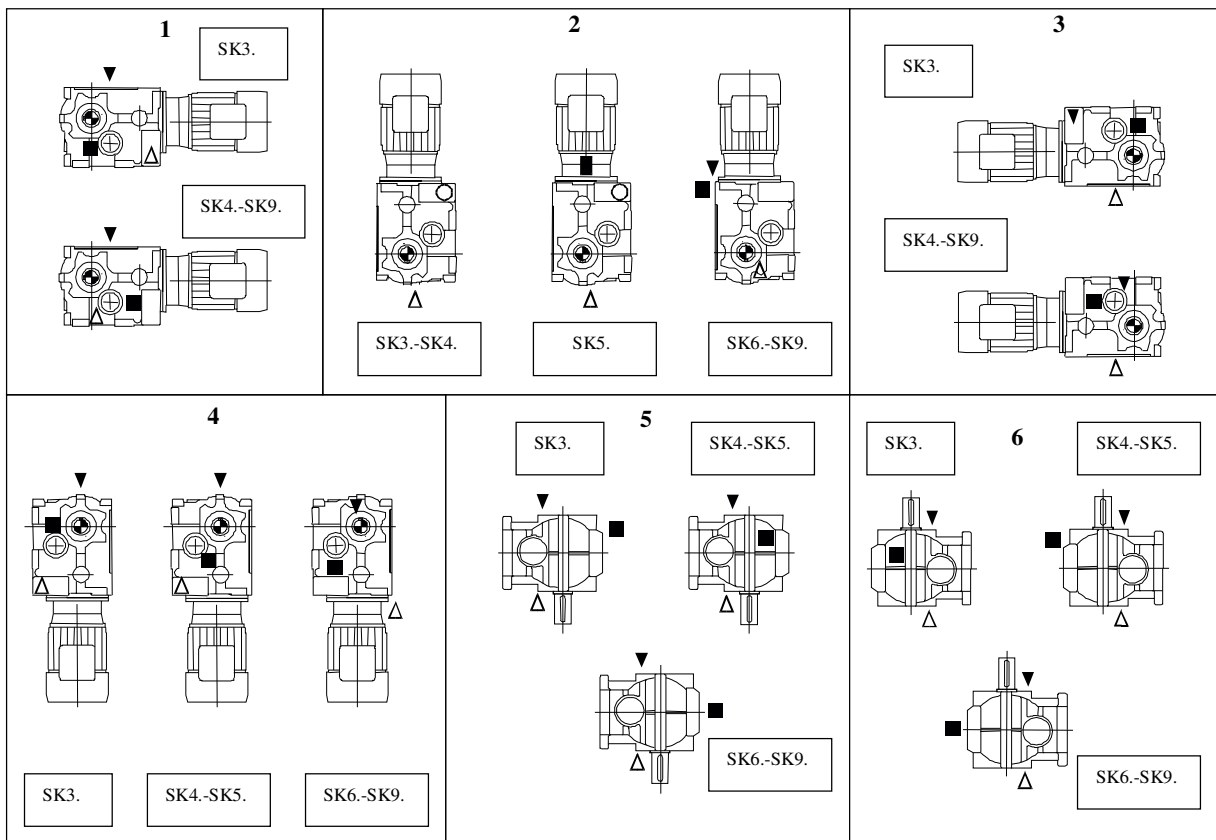

■	Oil level screw plug
□	Oil level screw plug, rear
△	Oil drain plug
△	Oil drain plug, rear
▼	Oil filler and breather valve
▼	Oil filler and breather valve, rear
■	Breather valve (for size 4 and 5 only)
●	Oil filler and oil level screw plug
○	Oil filler and oil level screw plug, rear

7.3 SK7 to SK9 with Pre-Stage SI3

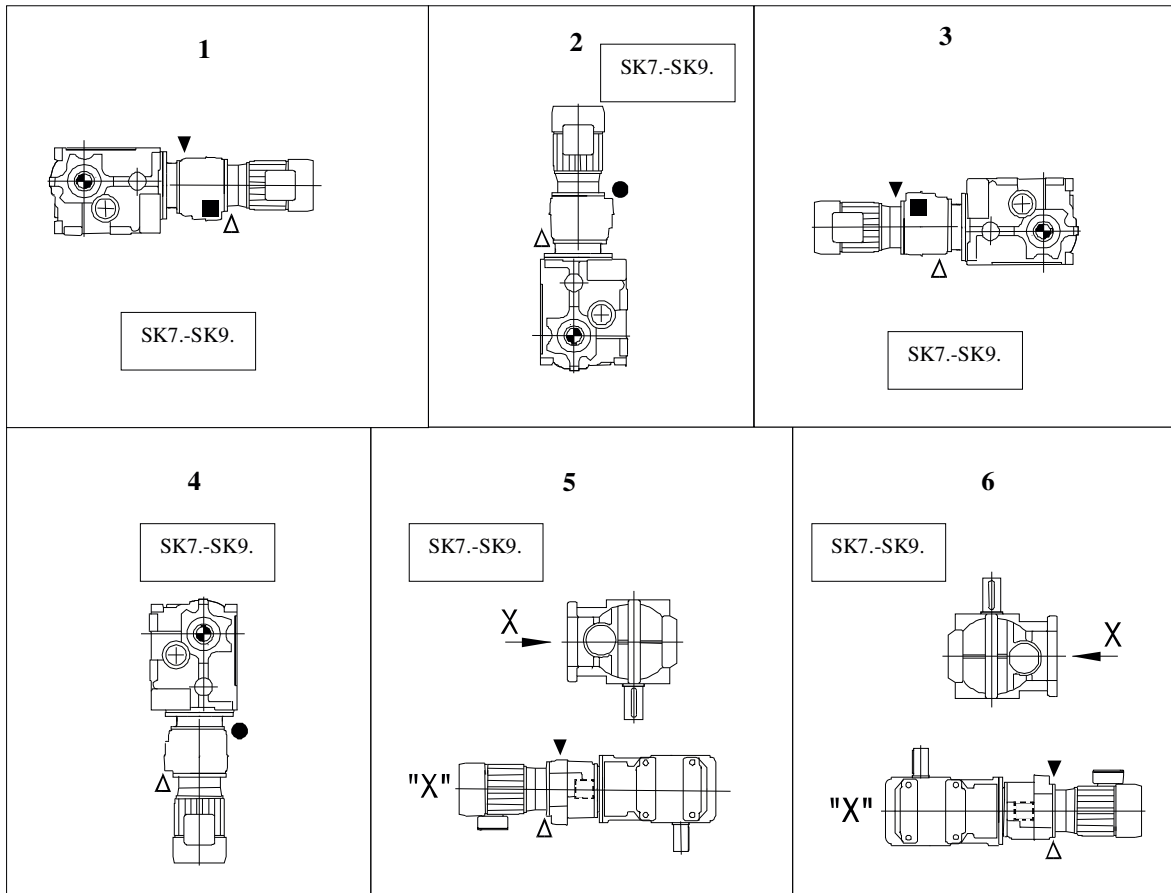

- Oil level screw plug
- Oil level screw plug, rear
- △ Oil drain plug
- △ Oil drain plug, rear
- ▼ Oil filler and breather valve
- ▽ Oil filler and breather valve, rear
- Breather valve (for size 4 and 5 only)
- Oil filler and oil level screw plug
- Oil filler and oil level screw plug, rear

7.4 Regreasing Facility for Roller Bearing Grease

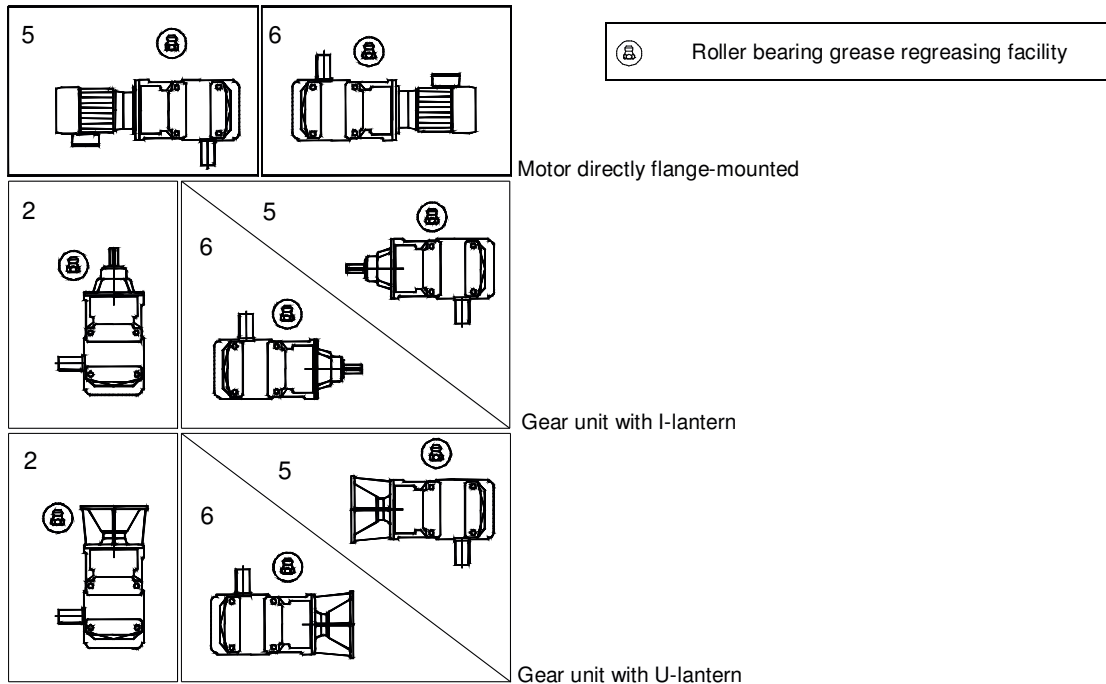

7.5 Oil Level Glass

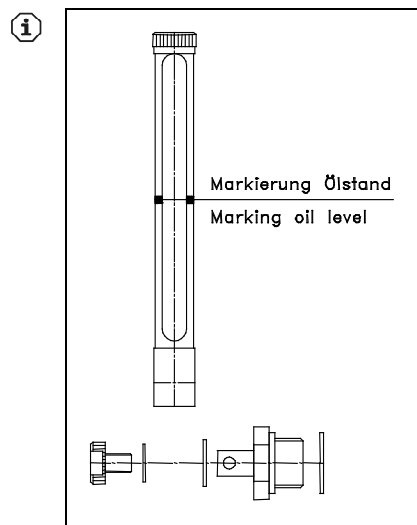

As from size 4, the gear unit can be equipped with an oil level glass for the purpose of simply reading off the oil level. The drive unit must be switched off when reading the oil level. The maximum deviation of the oil level from the oil level marking is specified in the table below. Level glasses equipped with capacitive sensors are also possible for the purpose of continuous oil level monitoring.

Size	Deviation from marking
SK4. ... SK6.	± 3 mm
SK7. ... SK9.	± 5 mm

7.6 Oil Filling

- ⓘ If gear units are supplied without an oil filling, do not fill the unit with oil before it has been installed in its final position. Always fill the gear unit up to the centre of the oil inspection glass / up to the oil level screw plug.

7.7 Draining Oil

- Ⓜ Drain off oil when warm, the breather screw should be removed beforehand. Take care when draining hot oil, use a suitable container. The drained oil must be disposed of in accordance with applicable environmental protection regulations.

7.8 Breathing

- M** **Size 2:** No breathing necessary.
Size 3 - 9: Gear units are equipped with a breather valve to avoid overpressure. Check the valve regularly to ensure it is operating satisfactorily.

7.9 Oil Expansion Tank

- i** The oil expansion tank serves the purpose of collecting the oil that has been foamed up by the gearing and expanded by the oil temperature to avoid it escaping from the gear unit. The oil expansion tanks each have a capacity of one litre. One or several tanks must be installed depending on the required expansion volume. It is necessary to check whether the oil expansion tank does not conflict with the connection sizes for the specific application. Please consult Rexnord-Stephan. The following table provides an overview of the standard Rexnord-Stephan oil expansion tanks.

Gear unit type	Mounting position	Speed [rpm]	Expansion volume [litres]
SK3. ... SK7.	2	all	1
SK8. ... SK9.	2	all	4
SK6. ... SK7.	5, 6	all	1
SK8. ... SK9.	5, 6	all	2
SK3. ... SK7.	5, 6	only for n >1500 rpm	1
SK8. ... SK9.	5, 6	only for n >1500 rpm	4

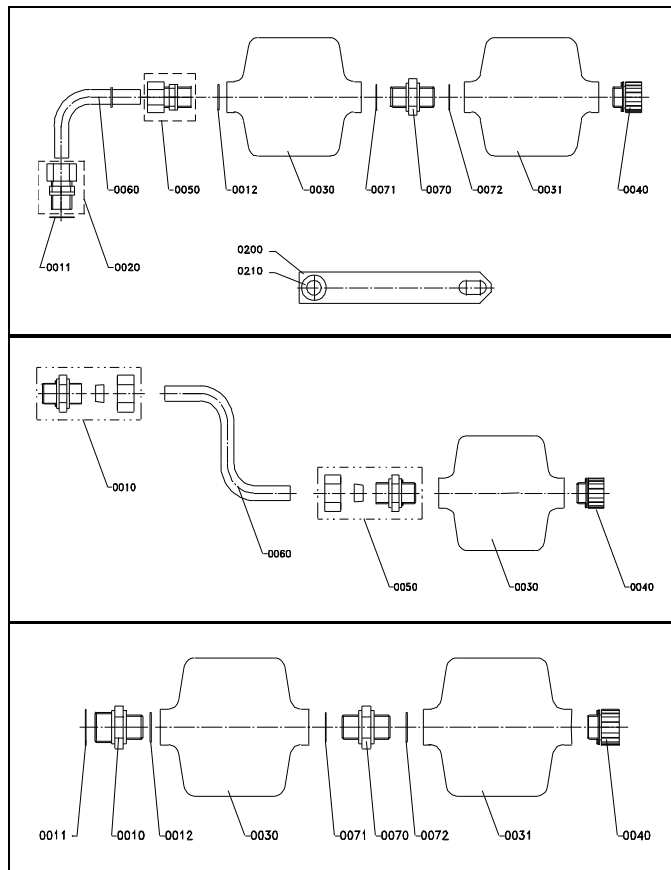

Item No.	Description
0010	Double fitting
0011	Seal
0012	Seal
0020	Pipe screw fitting
0030	Expansion tank
0031	Expansion tank
0040	Breather valve
0050	Pipe screw fitting
0060	Pipe
0070	Double fitting
0071	Seal
0072	Seal
0140	Sealing tape
0200	Mounting bracket
0210	Leadthrough grommet

8 EG Certificate of Conformity

Declaration by the Manufacturer Herstellererklärung



Machinery Directive
98/37/EEC

Maschinenrichtlinie
98/37/EG

Declaration by the Manufacturer
(In accordance with Article 4.2 and Annex II B of the above directive)

Herstellerklärung
(gemäß Artikel 4.2 und Anhang II B von der obigen Richtlinie)

PROHIBITION TO PUT INTO SERVICE

VERBOT DER INBETRIEBNAHME

We,

Hiermit erklären wir,

Rexnord-Stephan GmbH&Co.KG
Ohsener Straße 79-83
D 31789 Hameln
Germany,

Rexnord-Stephan GmbH&Co.KG
Ohsener Straße 79-83
D 31789 Hameln
Deutschland,

herewith declare that Gear Units and Geared Motors:

daß die Getriebe und Getriebemotoren:

SI4
SP4
SK4

SI4
SP4
SK4

are intended to be incorporated into machinery or to be assembled with other machinery to constitute machinery covered by Directive 98/37/EEC as amended, and furthermore declare that it is not allowed to put the gear unit and geared motor into service until the machinery into which they are to be incorporated or of which they are to be a component has been found and declared to be in conformity with the Machinery Directive and with national implementing legislation, i.e. as a whole, including the gear units and geared motors referred to in this declaration.

vorgesehen sind zum Einbau in eine Maschine oder mit anderen Maschinen zu einer Maschine, im Sinne der Richtlinie 98/37/EG inklusive deren Änderungen, zusammengefügt wird.

Desweiteren erklären wir, daß die Inbetriebnahme der Getriebe und Getriebemotoren solange untersagt ist, bis die Maschine, in welche sie eingebaut werden oder von welcher sie eine Komponente darstellen, als Ganzes (d.h. inklusive der Getriebe und Getriebemotoren, für welches diese Erklärung ausgestellt wurde) den Bestimmungen der Maschinenrichtlinie sowie dem entsprechenden nationalen Rechtserlass zur Umsetzung der Richtlinie ins nationale Recht entspricht, und die entsprechende Konformitätserklärung ausgestellt ist.

Applied harmonized standards:

DIN EN 292-1
DIN EN 292-2
DIN EN 294
DIN EN 349
DIN EN 60204-1

Angewandte harmonisierte Normen:

DIN EN 292-1
DIN EN 292-2
DIN EN 294
DIN EN 349
DIN EN 60204-1

Hameln, 2004 November



Dr. Detlev Petersen
Direktor Marketing und Technik
Director Marketing and Engineering

In case of electronic transmission the document remains validity also without signature.

Bei elektronischer Übermittlung bleibt das Dokument auch ohne Unterschrift gültig.

Editor: LJ	15.11.2004	3P0108-60	Copyright reserved	Page / Seite: 1/1
------------	------------	-----------	--------------------	-------------------

EC Certificate of Conformity EG Konformitätserklärung



EC Directive 89/336/EEC
"Electromagnetic Compatibility"
amended by RL 91/263/EEC, 92/31/EEC and
93/68/EEC

EG-Richtlinie 89/336/EWG
„Elektromagnetische Verträglichkeit“
geändert durch RL 91/263/EWG, 92/31/EWG und
93/68/EWG

EC Directive 73/23/EEC
"Electrical equipment designed for use
within certain voltage limits"
amended by RL 93/68/EEC

EG-Richtlinie 73/23/EWG
„Elektrische Betriebsmittel zur Verwendung
innerhalb bestimmter Spannungsgrenzen“
geändert durch RL 93/68/EWG

STATEMENT

We

Rexnord-Stephan GmbH & Co. KG
Ohsener Straße 79-83
D 31789 Hameln
Germany,

herewith declare that

**A. C. motors with
squirrel cage rotor
Size S63. to S280.**

correspond to the specification of the above
mentioned EC directive.
Following standards concur with the describe
products:

EN 50081-1; EN 50082-2
DIN EN 60034-1; DIN EN 60034-2; DIN EN 60034-5
DIN EN 60034-6; DIN EN 60034-9

This certificate attests the conformity with the named
directives, however, it is not a promise of properties
in the meaning of product liability!

Hameln, 2004 November



Dr. Detlev Petersen
Direktor Marketing und Technik
Director Marketing and Engineering

In case of electronic transmission the document remains validity
also without signature.

ERKLÄRUNG

Hiermit erklären wir

Rexnord-Stephan GmbH & Co. KG
Ohsener Straße 79-83
D 31789 Hameln
Deutschland,

dass die

**Asynchron-Drehstrommotoren mit
Käfigläufer
Baugröße S63. bis S280.**

mit den Vorschriften o.g. Europäischer Richtlinien
übereinstimmen.
Folgende Normen werden bei den bezeichneten
Produkten eingehalten:



















EN 50081-1; EN 50082-2
DIN EN 60034-1; DIN EN 60034-2; DIN EN 60034-5
DIN EN 60034-6; DIN EN 60034-9



Diese Erklärung ist keine Zusicherung von Eigen-
schaften im Sinne des Produkthaftungsgesetzes. Die
Sicherheitshinweise der Produktinformationen sind zu
beachten!

Bei elektronischer Übermittlung bleibt das Dokument auch ohne
Unterschrift gültig.

Ersteller: Editor:	LJ 06.07.2004	3P0109-02 Index 01	Copyright reserved	Seite Page 1/1
-----------------------	------------------	-----------------------	--------------------	-------------------

9 Sales and Service Branches

AUSTRALIA 		ITALY 	
Melbourne	Tel: + 61 3 97293300 Fax: + 61 3 97297626	Segrate (Milano)	Tel: + 39 02 2699271 Fax: + 39 02 26992750
Picton	Tel: + 61 2 46773811 Fax: + 61 2 46773812	JAPAN 	
AUSTRIA 		Tokyo	Tel: + 81 3 5224 3305 Fax: + 81 3 5224 3300
Authering	Tel: + 43 6223 204300 Fax: + 43 6223 2043020	LITHUANIA 	
BELGIUM 		Klaipėda	Tel: + 370 46 380888 Fax: + 370 46 400888
Antwerp	Tel: + 32 3 4501211 Fax: + 32 3 4501220	MALAYSIA 	
Brüssel / Vilvorde	Tel: + 32 2 2558300 Fax: + 32 2 2525282	Shah Alam	Tel: + 60 3 51226030 Fax: + 60 3 51226090
CANADA 		NETHERLANDS 	
Montreal	Tel: + 1 514 3372446 Fax: + 1 514 3372615	Zwijndrecht	Tel: + 31 78 6101666 Fax: + 31 78 6231121
Toronto	Tel: + 1 416 2976868 Fax: + 1 416 2976873	POLAND 	
CHINA 		Lodz	Tel: + 48 42 6748941 Fax: + 48 42 6741390
Changzhou	Tel: + 86 519 6480512 Fax: + 86 519 6483026	PORTUGAL 	
DENMARK 		Lisboa	Tel: + 35 1 217787249 Fax: + 35 1 217789877
Kopenhagen	Tel: + 45 45469700 Fax: + 45 45469701	SINGAPORE 	
FRANCE 		Singapore	Tel: + 65 3385622 Fax: + 65 3385422
Raon L'Etape (Nancy)	Tel: + 33 3 29526272 Fax: + 33 3 29418040	SWITZERLAND 	
Colombes (Paris)	Tel: + 33 1 47601960 Fax: + 33 1 47812929	Zürich	Tel: + 41 1 3012400 Fax: + 41 1 3013984
GERMANY 		SPAIN 	
Hameln	Tel: + 49 5151 7800 Fax: + 49 5151 780340	San Sebastian	Tel: + 34 3 943 457200 Fax: + 34 3 943 463356
Gevelsberg	Tel: + 49 2332 66360 Fax: + 49 2332 663630	SOUTH AFRICA 	
ISRAEL 		Boksburg	Tel: + 27 113972495 Fax: + 27 113972596
Emek Hefer	Tel: + 972 4 622 07 66 Fax: + 972 4 622 07 60	SWEDEN 	
		Bromma	Tel: + 46 8 4040100 Fax: + 46 8 4040198

TURKEY		
Bursa	Tel: + 90 533 6515596 Fax: + 90 224 2111507	
THAILAND		
Bangkok	Tel: + 66 2 4682999 Fax: + 66 2 4683338	
UNITED KINGDOM		
Huddersfield	Tel: + 44 1484 431414 Fax: + 44 1484 431426	

USA		
Colombus (OH)	Tel: + 1 614 675 3000 Fax: + 1 614 675 3001	
New Orleans (LA)	Tel: + 1 504 524 2363 Fax: + 1 504 528 9074	
Horsham (PA)	Tel: + 1 215 682 0400 Fax: + 1 215 773 4463	
Stuarts Draft (VA)	Tel: + 1 540 337 3510 Fax: + 1 540 337 1317	
Milwaukee (WI)	Tel: + 1 414 643 2576 Fax: + 1 414 643 2597	

When compiling these operating instructions, great care and importance was attached to ensuring the published information is correct. In view of continuous further development and improvements, we reserve the right to supply products that may vary slightly compared to the information provided in this publication. If you have any questions or require further information on our products, please contact one of our service or sales branches.

Notes